

# WELDAS<sup>®</sup>

*The Professional's Choice*



## 2018

*Europe Catalog No. 0118*



## WELCOME TO THE WELDAS EUROPE CATALOG!

This catalogue wants to inform you about the Weldas products which are manufactured in our own, by TÜV, ISO certified factory. Most of the products are also CE certified, again by TÜV, and you find the information with the products including the numbers of the certificates, copies of these certificates are always at your disposal:

[www.weldas-ce.com](http://www.weldas-ce.com). The pH, CHROMIUM (VI) and PCP levels of all materials in Weldas products have been tested and meet CE health standards. Colouring is done by natural materials. Please visit for more information our website: [www.weldas.com](http://www.weldas.com).



## WILKOMMEN IM WELDAS EUROPE KATALOG!

Dieser Katalog informiert Sie über die Weldas Produkte, die in unserem, vom TÜV, ISO zertifiziertem Werk, hergestellt werden. Die meisten Weldas Produkte sind vom TÜV nach den CE-Richtlinien zertifiziert. Die Nummern der Zertifikate entnehmen Sie bitte der Produktbeschreibung. Kopien sind selbstverständlich jederzeit zu erhalten:

[www.weldas-ce.com](http://www.weldas-ce.com). Die pH-, Chromium-(VI) und PCP-Werte aller Weldas Materialien sind nach den CE Gesundheitsstandards getestet. Zur Materialfärbung werden nur natürliche Farben verwendet. Bitte besuchen Sie auch unsere Homepage: [www.weldas.com](http://www.weldas.com).



## BIENVENUE DANS LE CATALOGUE WELDAS!

Ce catalogue a pour but de vous informer sur les produits Weldas, fabriqués dans notre propre usine et certifiés ISO par TÜV. La plupart de nos produits sont aussi certifiés CE pas TÜV. Vous trouverez ces information avec le produits, y compris les numéros des certificats, les copies de ces certificats sont toujours à votre disposition:

[www.weldas-ce.com](http://www.weldas-ce.com). Les niveaux de pH, Chrome (VI) et de PCP sont testés sur chaque produit Weldas et sont conformes aux standards de la santé CE. Les couleurs proviennent de matériaux naturels. Vous pouvez aussi visiter notre site: [www.weldas.com](http://www.weldas.com).



## WELKOM IN DE WELDAS EUROPE CATALOGUS!

Deze catalogus wil u informeren over de Weldas producten gefabriceerd in onze eigen, door TÜV, ISO gecertificeerde fabriek. De meeste van onze producten zijn CE gecertificeerd, door TÜV. De informatie hierover vindt u terug bij de producten, inclusief de nummers van de certificaten. Kopieën van deze certificaten zijn ten alle tijden bij ons verkrijgbaar: [www.weldas-ce.com](http://www.weldas-ce.com). De pH, CHROMIUM (VI) en PCP waarden van alle materialen in de Weldas producten zijn getest en voldoen aan de CE standaards. Verven van de producten gebeurt met natuurlijke materialen.

Bezoek voor meer informatie onze website: [www.weldas.com](http://www.weldas.com).



## BEM-VINDO AO CATÁLOGO EUROPEU DA WELDAS!

Este catálogo contem informações sobre os produtos Weldas produzidos na nossa própria fábrica, a qual possui certificação TÜV e ISO. A maior parte dos nossos produtos são também certificados pela CE e TÜV. Encontrará essa informação junto aos produtos. O número das certificações, assim como as cópias das mesmas estarão sempre à sua disposição: [www.weldas-ce.com](http://www.weldas-ce.com). Os níveis de PH, Crómio e PFC de todos os materiais dos produtos Weldas foram submetidos a teste e obedecem às normas de saúde da CE. A coloração é feita através de substâncias naturais.

Convidámo-lo a visitar o nosso site, onde poderá obter mais informações: [www.weldas.com](http://www.weldas.com).



## BIENVENIDO AL CATALOGO DE WELDAS EUROPE!

Este catalogo les ayudara informales sobre los productos de Weldas. Los productos son confeccionado bajo las normas de TÜV y llevan certificado ISO. La mayoría de los productos llevan también el certificado CE, impreso en los mismos productos Weldas. También les podemos facilitar copias de los certificados: [www.weldas-ce.com](http://www.weldas-ce.com). El pH, cromo y el nivel de PCP han sido ensayado y son conforme con los estándar CE de salud. El tenido de la piel se hace con materiales naturales. Por favor visiten nuestra pagina web: [www.weldas.com](http://www.weldas.com).



## BENVENUTI NEL CATALOGO WELDAS EUROPA!

Questo catalogo è stato concepito per informare su quanto la WELDAS produce in proprio attraverso un'azienda certificate ISO dal TUV. La maggior parte dei prodotti sono anche certificati CE, sempre dal TUV, e le copie di questi certificati sono comunque a vostra disposizione: [www.weldas-ce.com](http://www.weldas-ce.com). Il PH, il cromo (VI) ed i livelli PCP di tutti i materiali nei prodotti Weldas sono stati testate ed incontrano gli standard CE. La colorazione viene effettuata utilizzando solo sostanze naturali. Potete visitare il nostro sito all'indirizzo: [www.weldas.com](http://www.weldas.com).



## WITAMY W KATALOGU WELDAS EUROPE!

W niniejszym katalogu chcemy przedstawić Państwu produkty Weldas produkowane w naszej fabryce, certyfikowanej przez TÜV oraz spełniającej normy ISO. Większość naszych produktów jest również przetestowana przez TÜV i posiada niezbędne certyfikaty CE, które są zawsze do Państwa dyspozycji i o których więcej możecie Państwo przeczytać przy poszczególnych produktach: [www.weldas-ce.com](http://www.weldas-ce.com). Materiały używane do produkcji są regularnie testowane i spełniają wszelkie wymagania CE dla poziomów PH, chromu VI oraz PCP, a ich barwienie następuje przy użyciu naturalnych barwników. Po więcej informacji zapraszamy na naszą stronę: [www.weldas.com](http://www.weldas.com).



## VÄLKOMMEN TILL WELDAS EUROPE ´S KATALOG!

Med denna katalog vill vi informera er om Weldas ´ produkter, som är tillverkade i vår egen, av TÜV, ISO certifierade fabrik. De flesta av våra produkter är även CE certifierade, också av TÜV, och du kan hitta den informationen tillsammans med produkterna, inkluderande antalet certifikat. Kopior av certifikaten finns alltid tillgängliga för er: [www.weldas-ce.com](http://www.weldas-ce.com). pH-värdet, Krom (VI), och PCP halterna för alla material i Weldas ´ produkter har testats, och möter CE ´s hälsostandard. Färgning är gjord med naturmaterial. Besök gärna vår hemsida [www.weldas.com](http://www.weldas.com) för mer information!



## VELKOMMEN TIL WELDAS EUROPA'S KATALOG!

Med dette katalog vil vi informere om Weldas produkterne, som er fremstillet på vores egen fabrik, der er TÜV og ISO certificeret. Mange af produkterne er også CE certificeret, også af TÜV. Herudover er der informationer om produkterne, antal certifikater som ligger på vores hjemmeside til fri download: [www.weldas-ce.com](http://www.weldas-ce.com). Ph, Crom6 og formaldehyd grænserne på alle Weldas produkter er testet og over-holder EU standard. Indfarvning er udført med naturprodukter. Ønskes flere informationer, kan disse findes på: [www.weldas.com](http://www.weldas.com).



## VELKOMMEN TIL WELDAS EUROPA KATALOGEN!

Denne katalogen vil informere deg om Weldas produktene som er produsert i vår egen, by TÜV, ISO sertifiserte fabrikk. De fleste produktene er også CE sertifiserte, igjen av TÜV, og du vil finne informasjon inkludert nummrene på sertifikatene, kopier av disse sertifikatene er alltid tilgjengelige: [www.weldas-ce.com](http://www.weldas-ce.com). PH, CHROMIUM(VI) og PCP nivåene i alle Weldas produktene har blitt testet og imøteser CE helsestandarden. Fargingen er gjort med naturlige materialer. For mer informasjon besøk vår hjemmeside: [www.weldas.com](http://www.weldas.com).



## TERVETUOLOA TARKASTELEMAAN WELDAS EUROPEN LUETTELOA!

Tämä luettelo haluaa antaa tietoja Weldasin tuotteista, jotka on valmistettu omassa TÜV- ja ISO-sertifioidussa tehtaassamme. Suurimmalla osalla tuotteista on myös TÜV:n myöntämä CE-sertifikaatti. Löydät nämä tiedot tuotteiden kohdalta yhdessä sertifikaatin numeron kanssa. Voit halutessasi saada kopiot sertifikaateista: [www.weldas-ce.com](http://www.weldas-ce.com). Kaikkien Weldasin tuotteissa käytettyjen materiaalien pH-, kromi(VI)- ja PCP-arvot on testattu, ja ne ovat CE-terveysstandardien mukaisia. Värjäys on tehty luonnollisilla aineilla. Enemmän tietoa löytyy verkkosivuiltamme: [www.weldas.com](http://www.weldas.com).

## TERE TULEMAST KOMPANII WELDAS EUROOPA KATALOOGI!

Käesoleva kataloogiga me soovime Teid informeerida Weldas toodetest. Weldas on TÜV-i liige, sellepärast kõik meie tehases valmistatud tooted sertifitseeritakse ISO-ga. Suurem osa toodangut omab samuti märki CE. Teie käsutuses on sertifikaatide loetelu ja koopiad koos toodetega: [www.weldas-ce.com](http://www.weldas-ce.com). Happesuse (pH), kroomi (IV) ja PCP tase Weldas toodetes on testitud ja vastab CE tervise standartile. Toodete värvimine on teostatud naturaalse ainetega. Täpsema informatsiooni saamiseks, külastage meie web: [www.weldas.com](http://www.weldas.com).

## LAIPNI LŪGTI WELDAS EUROPE KATALOGĀ!

Sajā katalogā vēlamies informēt par Weldas precēm, ražotām mūsu pašu rūpnīcā, kurai ir TUV un ISO sertifikāts. Vairumam preču ir arī TUV izsniegts CE sertifikāts, par kuru vajadzīgo informāciju jūs atradīsiet pie attiecīgajām precēm, ieskaitot sertifikātu numurus, šo sertifikātu kopijas vienmēr ir jūsu rīcībā: [www.weldas-ce.com](http://www.weldas-ce.com). pH, hroma (VI) un PCP līmenis visos Weldas precēs izmantotajos materiālos ir pārbaudīts un atbilst CE veselības standartiem. Krāsām ir izmantoti dabīgi materiāli. Lai iegūtu vairāk informācijas, lūdzu apmeklējiet mūsu mājas lapu: [www.weldas.com](http://www.weldas.com).

## SVEIKI ATVYKĖ Į WELDAS EUROPE KATALOGĄ!

Siame kataloge norime jus informuoti apie Weldas produktus, kuriuos gaminame patys gamykloje turinčioje ISO sertifikata. Didesnė dauguma mūsų produkcijos turi EB tipo tyrimo sertifikatus. Visus sertifikatus ir informaciją apie produktus rasite mūsų internetiniame puslapyje: [www.weldas-ce.com](http://www.weldas-ce.com). Visi Weldas produktai yra patikrinti dėl PH lygio, chromo kiekio ir PCP ir atitinka visus EB keliamus sveikatos reikalavimus. Taip pat norime paminėti, kad visi mūsų produktai yra dažomi natūraliomis medžiagomis. Dėl platesnės informacijos apie mūsų produktus prašome apsilankyti mūsų internetiniame puslapyje: [www.weldas.com](http://www.weldas.com).

## Добро пожаловать в Европейский каталог компании Weldas!

В этом каталоге мы хотим представить Вам информацию о продукции Weldas. Weldas является членом TÜV, поэтому все изделия, производимые на нашем заводе, сертифицируются ISO. Большая часть продукции имеет также знак CE. Также в Вашем распоряжении вместе с продукцией перечень сертификатов и их копии: [www.weldas-ce.com](http://www.weldas-ce.com). Уровни pH, хрома (IV) и PCP материалов в продукции Weldas тестированы и соответствуют стандартам здоровья CE. Окраска изделий произведена натуральными веществами. Для получения более подробной информации посетите наш сайт: [www.weldas.com](http://www.weldas.com).



## VÍTEJTE NA STRÁNKÁCH WELDAS EUROPE KATALOGU!

Tento katalog má za cíl vás informovat o produktech Weldas, které jsou vyráběny v naší vlastní, TÜV a ISO certifikované továrně. Většina produktů je nejen podle CE (evropských norem) certifikována, ale rovněž také zkoušena TÜV a informace o tom naleznete pod číslem certifikátu na výrobku. Kopie certifikátů jsou vám vždy k dispozici: [www.weldas-ce.com](http://www.weldas-ce.com). Hodnoty pH, Chromu (VI) a výkonostní stupně všech používaných materiálů firmou Weldas byly testovány a vyhovují CE evropským zdravotním normám. Barvení je provedeno přírodními materiály. Prosím, pro více informací navštivte naše webové stránky: [www.weldas.com](http://www.weldas.com).

## VITAJTE V KATALÓGU WELDAS EUROPE!

Tento katalóg by Vás rád informoval o produktoch Weldas, ktoré sú vyrábané v našej vlastnej továrni, certifikovanej podľa noriem TÜV a ISO. Väčšina týchto produktov je takisto certifikovaná podľa noriem CE, a tiež podľa noriem TÜV. V katalógu nájdete pri produktoch informácie ohľadom počtu certifikátov. Kópie týchto certifikátov budete mať neustále k dispozícii: [www.weldas-ce.com](http://www.weldas-ce.com). Hodnoty pH, chrómu a PCP všetkých materiálov v produktoch Weldas sú testované a vyhovujú európskym zdravotným normám CE. Zafarbenie produktov je realizované farbivami z prírodných materiálov. Prosím navštívte našu webovú stránku: [www.weldas.com](http://www.weldas.com), kde získate viac informácií.

## KÖSZÖNTI ÖNTA WELDAS EURÓPA CATALOG!

Ez a katalógus a Weldas termékekről nyújt Önnek információt, melyek a saját, TÜV illetve ISO minősítéssel rendelkező gyárunkban készültek. A termékeink többsége CE tanúsítvánnyal illetve TÜV bevizsgálással rendelkezik. A tanúsítvány számára vonatkozó hivatkozást a termékeknél találja, és ezen tanúsítványok másolata mindenkor az Ön rendelkezésére áll: [www.weldas-ce.com](http://www.weldas-ce.com). A Weldas termékek anyagainak pH, Chromium (VI) és PCP szintjeit mindenkor ellenőrzik, melyek a CE egészségügyi standard előírásainak megfelelnek. A termékek színezése csak természetes anyagokkal történik. Kérjük további információért keresse fel honlapunkat: [www.weldas.com](http://www.weldas.com).

## BINE AȚI VENIT LA CATALOGUL WELDAS EUROPE!

Acest catalog vă informează despre produsele Weldas, care sunt fabricate în fabrici proprii, certificate TUV sau ISO. Majoritatea produselor sunt atestate CE, de asemenea și TUV și puteți găsi toate informațiile despre produse, incluzând numărul certificatelor, copii ale acestora sunt la dispoziția dumneavoastră: [www.weldas-ce.com](http://www.weldas-ce.com). Nivelul pH, Crom (VI) și PCP pentru toate materialele produselor Weldas au fost testate și îndeplinesc standardele de sănătate CE. Vopsirea se realizează cu material naturale. Pentru informații suplimentare vă rugăm să vizitați website-ul nostru: [www.weldas.com](http://www.weldas.com).

## ДОБРЕ ДОШЛИ НА СТРАНИЦИТЕ НА КАТАЛОГА НА WELDAS!

Този каталог има за цел да ви информира за продуктите, предлагани от Weldas и произведени в сертифицираната по ISO и TÜV фабрика на Weldas. Повечето от продуктите имат CE маркировка и сертификати, издадени от TÜV. Информация за номерата на сертификатите и самите сертификати са винаги на разположение на клиентите: [www.weldas-ce.com](http://www.weldas-ce.com). Стойността на pH, съдържанието на хром (VI) и PCP нивото на всички материали, от които се произвеждат продуктите на Weldas съответстват на CE здравните изисквания. Естествени материали се използват при багрнето на продуктите. За повече информация посетете: [www.weldas.com](http://www.weldas.com).

## DOBRODOŠLI V EVROPSKEM KATALOGU WELDAS!

S tem katalogom Vas želimo obvestiti o izdelkih Weldas iz naše lastne TÜV in ISO certificirane proizvodnje. Večina naših izdelkov ima CE certifikat (prav tako izdan s strani TÜV), kar je ob izdelkih označeno s številko certifikata, kopije certifikatov pa so vam vedno na voljo: [www.weldas-ce.com](http://www.weldas-ce.com). Vrednosti pH, heksavalantnega kroma in PCP v materialih, ki jih uporablja Weldas, so preverjene in ustrezajo standardom EN. Za barvanje uporabljamo le naravne materiale. Vabimo Vas, da obiščete našo spletno stran: [www.weldas.com](http://www.weldas.com).

## DOBRODOŠLI U EUROPSKI WELDAS-ov KATALOG!

Ovaj katalog Vas želi informirati o Weldasovim proizvodima koji su proizvedeni u našoj vlastitoj tvornici, koja ujedno posjeduje i ISO certifikat izdan od strane TUV certifikacijske kuće. Velika većina naših proizvoda certificirana je i ima CE oznaku, izdanu od TUV-a. Uvijek možete saznati sve informacija o proizvodima uključujući i broj certifikata. Isto tako kopije ovih certifikata u svakom trenutku dostupne su vam preko naše web stranice: [www.weldas-ce.com](http://www.weldas-ce.com). pH, krom (VI) i PCP razine svih Weldasovih proizvoda permanentno se provjeravaju i testiraju, te zadovoljavaju sve CE zdravstvene standarde. Bojanje se vrši prirodnim materijalima. Za više informacija molim Vas posjetite našu web stranicu: [www.weldas.com](http://www.weldas.com).

## DOBRODOŠLI U WELDASOV KATALOG ZA EVROPU!

Katalog vam pruža informacije o Weldasovim proizvodima, proizvedenim u našoj TÜV i ISO certifikovanoj fabrici. Većina proizvoda poseduje CE certifikat izdat od strane TÜV - a, takođe u katalogu možete pronaći informacije o broju certifikata za svaki proizvod, kopije istih su vam uvek na raspolaganju: [www.weldas-ce.com](http://www.weldas-ce.com). PH, CHROMIUM (VI) i PCP nivoi svih materijala korišćenih u Weldasovim proizvodima su testirani i u skladu sa CE zdravstvenim standardima. Za bojenje proizvoda su korišćeni prirodni materijali. Za više informacija posetite našu internet prezentaciju na: [www.weldas.com](http://www.weldas.com).

## COMFOflex® WELDING GLOVES



Cotton lining

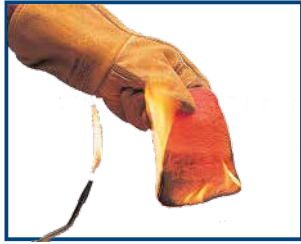

Foam lining



COMFOflex® lining

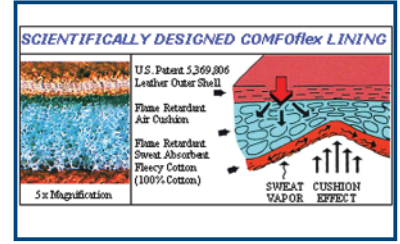

COMFOflex®

### 10-2000



S, L, XL, XXL  
LH  
L/18"

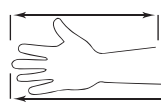

35 cm.  
46 cm. (L/18")

- A-grade cow split leather
- Hand COMFOflex® lined
- Cuff cotton lined
- Wide body model
- Size L also available in Left Hand only pairs (LH) and 18" (46 cm.)



95%

KEVLAR® 4 ply + 5 ply

COMFOflex®

EN 12477 (09.2005) TYPE A  
TÜV BP 60017622 0001  
TÜV 21128415 002



413X3X



4133

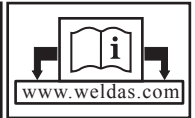

www.weldas.com

Ω ELECTROSTATIC TESTED Ω

### 10-2178



L

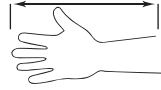

35 cm.

- Same features like the 10-2000 glove
- One finger model



95%

KEVLAR® 4 ply

COMFOflex®

EN 12477 (09.2005) TYPE A  
TÜV BP 60017622 0002  
TÜV 21128415 002



413X3X



4133

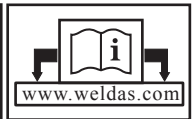

www.weldas.com

Ω ELECTROSTATIC TESTED Ω

### 10-2087



L, XL

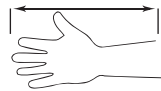

35 cm.

- A-grade cow shoulder split leather
- Hand full COMFOflex® lined
- Cuff cotton lined
- Wide body model



95%

KEVLAR® 4 ply + 5 ply

COMFOflex®

EN 12477 (09.2005) TYPE A/B  
TÜV BP 60017622 0002  
TÜV 21128415 002



413X3X



4133

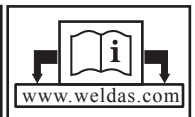

www.weldas.com

Ω ELECTROSTATIC TESTED Ω

## COMFOflex® WELDING GLOVES

10-2900



L, XL

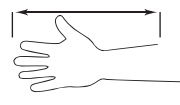

36 cm.

- A-grade cow split leather
- Hand COMFOflex® and wool lined
- Cuff flame retardant lined
- Wide body model



70%

**250°C CONTACT**

KEVLAR® 4 ply + 5 ply

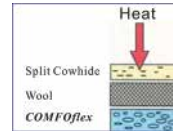

**STEERSOtuff®**

EN 12477 (09.2005) TYPE A  
TÜV BP 60017622 0001  
TÜV 21128415 002



10-2655



M, L, XL, XXL

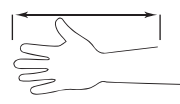

37 cm.

- Hand bison leather
- Cuff split cowhide
- Inner back of the hand COMFOflex® lined
- Cuff flame retardant lined
- **CHROMIUM < 2 mg./kg.**



30%

**250°C CONTACT**

KEVLAR® 4 ply + 5 ply



**ThunderingBison™**

EN 12477 (09.2005) TYPE A/B  
TÜV BP 21146065 001  
TÜV 556-10-0071/01



10-2850



L, XL

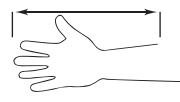

36 cm.

- Grain and split deerskin
- Backhand COMFOflex® lined and inner cuff flame retardant lined
- Highest comfort level



30%

KEVLAR® 4 ply + 5 ply



**DEERSOsoft®**

EN 12477 (09.2005) TYPE A/B  
TÜV BP 60017622 0001  
TÜV 21128415 002





## COMFOflex® WELDING GLOVES

10-2750



L, XL, XXL

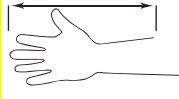

36 cm.

- A-grade cow grain leather
- Backhand **COMFOflex**® lined and cuff cotton lined
- Back palm reversed grain (suede)
- Oil and water resistant
- Excellent quality and comfortable to wear



30%

**250°C CONTACT**

KEVLAR® 4 ply + 5 ply



**STEERSOstuff**®

EN 12477 (09.2005) TYPE A/B  
TÜV BP 60017622 0002  
TÜV 21128415 002



Ω ELECTROSTATIC TESTED Ω

10-2755



L, XL

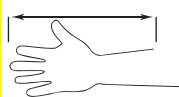

36 cm.

- Combined features:
- on the back of our 10-2385
- and the innerhand of the 10-2750 with extra comfort padges
- Oil and water resistant
- Excellent quality and comfortable to wear



30%

**350°C CONTACT**

KEVLAR® 4 ply + 5 ply

95% Radiant Heat

Aluminized  
PFR Rayon  
Split Deerskin  
**COMFOflex**

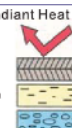

**COMFOflex**®

EN 12477 (09.2005) TYPE A/B  
TÜV BP 60022511 0001  
TÜV 21136762 003

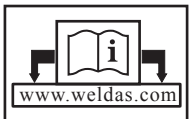

10-2385



L, XL, XXL

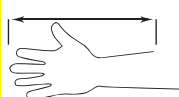

35 cm.

- A-grade cow side split leather
- Hand full **COMFOflex**® lined and cuff full flame retardant lined
- Wide body model
- Aluminized back is designed to reflect radiant heat and has a layer of split deerskin in between the back and **COMFOflex**® lining



35%

KEVLAR® 4 ply

95% Radiant Heat

Aluminized  
PFR Rayon  
Split Deerskin  
**COMFOflex**

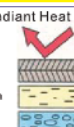

**COMFOflex**®

EN 12477 (09.2005) TYPE A  
TÜV BP 60017622 0001  
TÜV 21128415 002

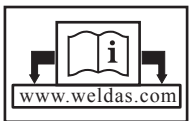

+



=



44-3006LB, 44-3008LB, 44-3009BF:  
see page 39

## COTTON LINED WELDING GLOVES

### 10-2392



L, XL  
LH/L, LH/XL  
  
L/18"

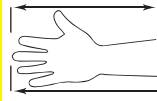

34 cm.  
  
46 cm. (L/18)

- Cow shoulder split leather
- Full cotton lined
- Straight thumb helps the user to handle a mig gun a lot better
- Size L also available in 18" (46 cm.)
- Size L and XL also available in Left Hand only pairs (LH)



95%

KEVLAR® 3 ply

EN 12477 (09.2005) TYPE A/B  
TÜV BP 60017622 0002  
TÜV 21128415 002



### 10-2392 MIT



L

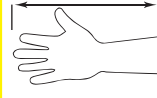

34 cm.

- One finger model of glove 10-2392
- Cow shoulder split leather
- Full cotton lined



95%

KEVLAR® 3 ply

EN 12477 (09.2005) TYPE A/B  
TÜV BP 60017622 0002  
TÜV 21128415 002



### 10-2392GB



L, XL

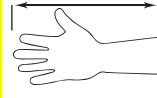

34 cm.

- Same as glove 10-2392, but *Golden Brown™* model
- Cow shoulder split leather
- Full cotton lined
- Straight thumb helps the user to handle a mig gun a lot better



95%

KEVLAR® 3 ply

EN 12477 (09.2005) TYPE A/B  
TÜV BP 60017622 0002  
TÜV 21128415 002



### 10-2150



L, XL



36 cm.

- Innerhand is made of cow grain leather to make it oil and water resistant
- All other parts of the glove are made of cow split leather
- Full cotton lined



95%

**250°C CONTACT**

EN 12477 (09.2005) TYPE A/B  
TÜV BP 60022511 0001  
TÜV 21136762 003







## COTTON LINED WELDING GLOVES

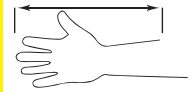

### 10-2101



 L, XL	 34 cm.	EN 12477 (09.2005) TYPE A/B TÜV BP 60017622 0003 TÜV 21128415 002 CE
<ul style="list-style-type: none"> <li>- The 10-2101 is our general purpose glove of the range</li> <li>- Cow shoulder split leather</li> <li>- Full cotton lined</li> <li>- Size L and XL also available in Left Hand only pairs (LH)</li> </ul>		
 90%		

### 10-2101GB

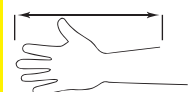

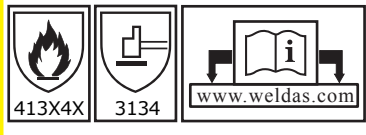
 L, XL	 34 cm.	EN 12477 (09.2005) TYPE A/B TÜV BP 60017622 0003 TÜV 21128415 002 CE
<ul style="list-style-type: none"> <li>- Same as glove 10-2101, but <i>Golden Brown™</i> model</li> <li>- Cow shoulder split leather</li> <li>- Full cotton lined</li> </ul>		
 90%		

Weldas sizing incorporates EN 420 size standards, the lining and the intended use

### (EN 420)

#### GLOVE AND HAND SIZE REFERENCE

Hand Size Index	7½	8½	9	9½	10½
Weldas Size Label	S	M	L	XL	XXL
Measurement mm	190	216	229	241	267

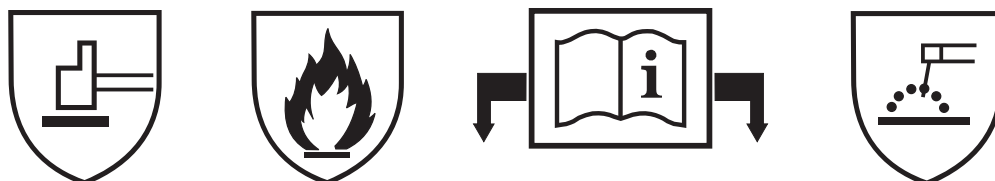
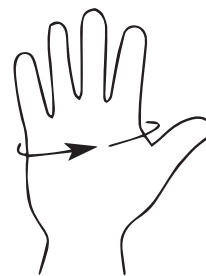

# WWW.WELDAS-CE.COM

## SOFTouch™ TIG WELDING GLOVES

### 10-1003



M, L, XL, XXL

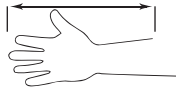

35 cm.

- Oil and abrasion resistant
- Reversed (suede) grain pig leather
- Seamless index finger

KEVLAR® 3 ply

SOFTouch™

EN 12477 (09.2005) TYPE A/B  
TÜV BP 60017622 0003  
TÜV 21128415 002



### 10-1004



S, M, L, XL, XXL

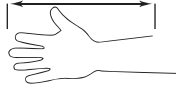

35 cm.

- Hand made of goatskin
- Double leather in the palm
- Very soft and excellent feeling
- Cuff made of grey flame retardant fabric

KEVLAR® 3 ply

**NEW**  
model

SOFTouch™

EN 12477 (2001 + A1 : 2005)  
TYPE B  
TÜV BP 60118529 0001  
TÜV 21264046 002



### 10-1005



S, M, L, XL, XXL

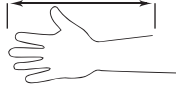

35 cm.

- Very smooth and pliable
- Calfskin grain leather
- Seamless index finger

KEVLAR® 3 ply

SOFTouch™

EN 12477 (09.2005) TYPE A/B  
TÜV BP 60017622 0003  
TÜV 21128415 002



Ω ELECTROSTATIC TESTED Ω

### 10-1007



M, L, XL

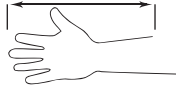

35 cm.

- Goatskin palm
- Cow split leather back and cuff

KEVLAR® 3 ply

SOFTouch™

EN 12477 (09.2005) TYPE B  
TÜV BP 60017622 0003  
TÜV 21128415 002



## SOFTouch™

## TIG WELDING GLOVES

10-1009



M, L, XL, XXL

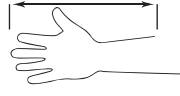

35 cm.

- Hand made of goatskin
- Very soft and excellent feeling
- Cuff made of split cow leather
- Seamless index finger

KEVLAR® 3 ply

SOFTouch™

EN 12477 (09.2005) TYPE B  
TÜV BP 60017622 0004  
TÜV 21128415 002



Ω ELECTROSTATIC TESTED Ω

10-1050



M, L, XL, XXL

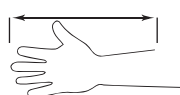

32 cm.

- Outer hand made of soft black grain cow leather
- White grain goat leather spacers on the sides of the fingers
- Curved cuff made of supple split cow leather trimmed at the edge with white grain goat leather
- Thin fleecy, flame retardant lining at the back of the hand
- Seamless index finger

KEVLAR® 4 ply

SOFTouch™

EN 12477 (2001 + A1 : 2005)  
TYPE A/B  
TÜV BP 60042511 0001  
TÜV 21177510 001



10-2304



M, L, XL, XXL



32 cm.

- Hand made of deerskin
- Very soft feeling
- Cuff made of split cow leather

KEVLAR® 3 ply



DEERSOsoft®

EN 12477 (09.2005) TYPE A/B  
TÜV BP 60017622 0004  
TÜV 21128415 002

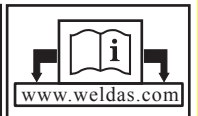

10-2644



M, L, XL, XXL



32 cm.

- Hand bison leather
- Cuff split cowhide
- **CHROMIUM < 2 mg./kg.**



KEVLAR® 3 ply



ThunderingBison™

EN 12477 (09.2005) TYPE A/B  
TÜV BP 21146065 001  
TÜV 556-10-0071/01





## WORKING GLOVES

### 10-2660



L, XL

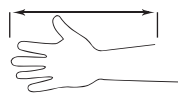

23 cm.

- Work glove designed for general purpose applications
- Grain pig leather with stretchy spandex glove back
- Wrist closable with a hook and loop closure for good fit of the glove

CE minimal risk



According to 89/686/EEC:  
not to be used in an  
industrial environment

CE

### 10-2670



M, L, XL, XXL

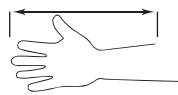

23 cm.

- Work glove designed for general purpose applications
- Grain goat leather with stretchy spandex glove back
- Wrist closable with a hook and loop closure for good fit of the glove

CE minimal risk



According to 89/686/EEC:  
not to be used in an  
industrial environment

CE

### 10-2680



L, XL

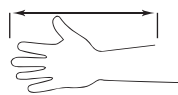

23 cm.

- Work glove designed for general purpose applications
- Grain cow leather with stretchy spandex glove back
- Wrist closable with a hook and loop closure for good fit of the glove

CE minimal risk



According to 89/686/EEC  
not to be used in an  
industrial environment

CE



## WORKING GLOVES

10-2806



L

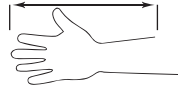

25 cm.

- Cow split leather
- Double leather in the palm
- Cotton lined
- Rubberized safety cuff

EN 388 (2003)  
TÜV BP 60017626 0001  
TÜV 21128304 002



CE

10-2209



S, M, L, XL, XXL

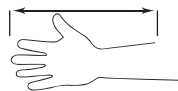

26 cm.

- A-grade cow split leather
- Cotton lined
- Rubberized safety cuff

EN 388 (2003)  
TÜV BP 60017626 0001  
TÜV 21128304 002



CE

10-2209LB



L, XL

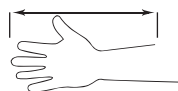

26 cm.

- A-grade cow split leather
- Cotton lined
- Rubberized safety cuff
- *Lava Brown™* model

EN 388 (2003)  
TÜV BP 60017626 0001  
TÜV 21128304 002



CE

10-2207



L, XL



25 cm.

- Cow split leather
- Cotton lined
- Safety cuff

EN 388 (2003)  
TÜV BP 60017626 0001  
TÜV 21128304 002



CE

## DRIVER GLOVES

### 10-2064



L, XL

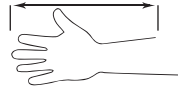

24 cm.

- Durable split cow leather

EN 388 (2003)  
TÜV BP 60017626 0002  
TÜV 21128304 002



### 10-2336



M, L, XL

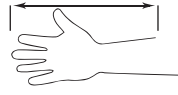

24 cm.

- Palm made of cow grain side leather
- Back made of split cow leather
- Extra fingertip sensitivity



EN 388 (2003)  
TÜV BP 60017626 0002  
TÜV 21128304 002

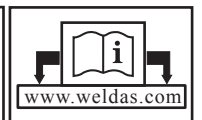

### 10-2633



M, L, XL, XXL

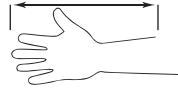

25 cm.

- Innerhand made of grain bison leather
- Back made of split cow leather
- **CHROMIUM < 2 mg./kg.**



KEVLAR® 3 ply



EN 388 (2003)  
TÜV BP 21146066 001  
TÜV 556-10-0071/02

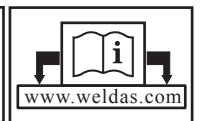

### 10-2700



S, M, L, XL, XXL

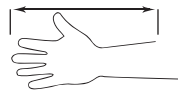

26 cm.

- Cow grain side leather of the highest quality
- Oil and water resistant

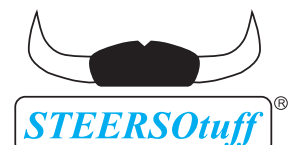

EN 388 (2003)  
TÜV BP 60017626 0002  
TÜV 21128304 002

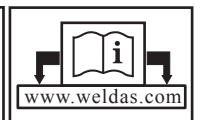





*COMFOflex*<sup>®</sup>

*SOFTouch*<sup>™</sup>

*DEERSOsoft*<sup>®</sup>

*ThunderingBison*<sup>™</sup>

*TURMOflex*<sup>®</sup>

*Lava Brown*<sup>™</sup>

*STEERSOtuff*<sup>®</sup>

*Arc Knight*<sup>®</sup>

*Arc Queen*<sup>™</sup>

*Golden Brown*<sup>™</sup>

*Fire Fox*<sup>™</sup>

*Yellowjacket*<sup>®</sup>

*SWEATSOpad*<sup>®</sup>

*COMBOframe*<sup>™</sup>

*LAVAshield*<sup>®</sup>

*PYTHONrap*<sup>™</sup>

## Lava Brown™ CLOTHING

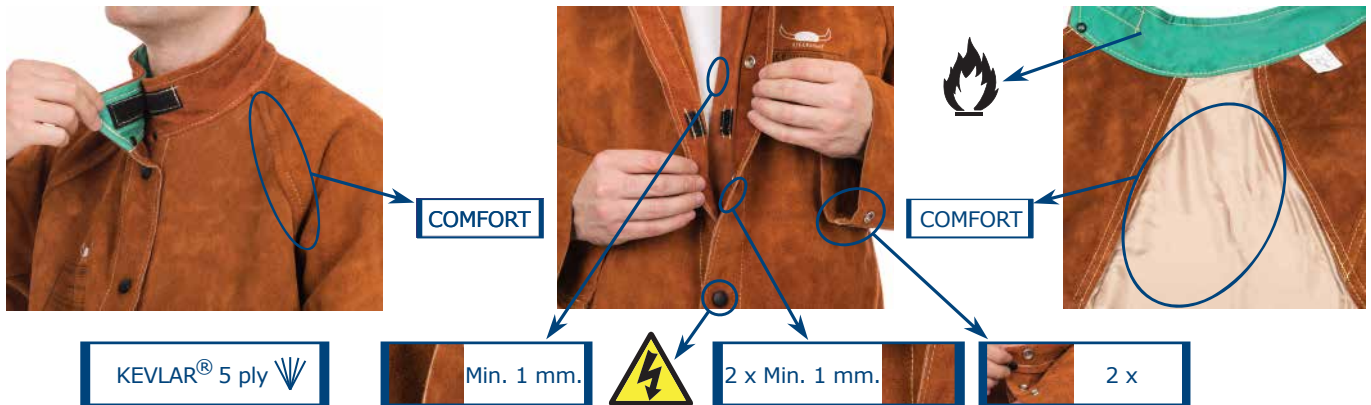

Lava Brown™ products are made of high quality A-grade side split cow leather

### 44-7300 Jacket full leather



- A-grade side split cow leather
- KEVLAR® 5 ply
- Leather thickness: min. 1 mm.

44-7300M	76 cm.	100 cm.
44-7300L	81 cm.	112 cm.
44-7300XL	86 cm.	124 cm.
44-7300XXL	91 cm.	136 cm.
44-7300XXXL	96 cm.	148 cm.
44-7300XXXXL	96 cm.	160 cm.



EN ISO 11611:2007  
CLASS 2/A1  
TÜV BP 60041277 0001  
TÜV 21173205 001

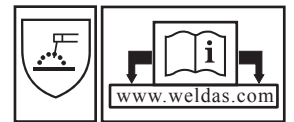

**EN ISO 11611:2007  
CLASS 2/A1**

### 44-7300/P Jacket with flame retardant back



- A-grade side split cow leather
- KEVLAR® 5 ply
- Leather thickness: min. 1 mm.
- Back: flame retardant cotton 315 gr/m²

44-7300M/P	76 cm.	100 cm.
44-7300L/P	81 cm.	112 cm.
44-7300XL/P	86 cm.	124 cm.
44-7300XXL/P	91 cm.	136 cm.
44-7300XXXL/P	96 cm.	148 cm.



EN ISO 11611:2007  
CLASS 2/A1  
TÜV BP 60041277 0001  
TÜV 21173205 001

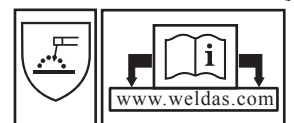

**EN ISO 11611:2007  
CLASS 2/A1**



## Lava Brown™ CLOTHING

### 44-7300/P-AQ Ladies jacket with flame retardant back



- A-grade side split cow leather
- KEVLAR® 5 ply
- Leather thickness: min. 1 mm.



44-7300S/P-AQ	76 cm.	98 cm.
44-7300M/P-AQ	76 cm.	110 cm.
44-7300L/P-AQ	81 cm.	120 cm.
44-7300XL/P-AQ	86 cm.	130 cm.

### 44-7800 Cape sleeve



- A-grade side split cow leather
- KEVLAR® 5 ply
- Leather thickness: min. 1 mm.

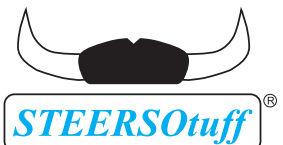

EN ISO 11611:2007  
CLASS 2/A1  
TÜV BP 60041277 0001  
TÜV 21173205 001



**EN ISO 11611:2007  
CLASS 2/A1**

44-7800M	100 cm.
44-7800L	112 cm.
44-7800XL	124 cm.
44-7800XXL	136 cm.
44-7800XXXL	148 cm.

### 44-78.. Apron for cape sleeves



- A-grade side split cow leather
- KEVLAR® 5 ply
- Leather thickness: min. 1 mm.



EN ISO 11611:2007  
CLASS 2/A1  
TÜV BP 60041277 0001  
TÜV 21173205 001



**EN ISO 11611:2007  
CLASS 2/A1**





## Lava Brown™ CLOTHING

**44-7248**

**Pants with breast protection and open back**

**44-7440**

**Pants with open back**



122 cm.

- A-grade side split cow leather
- KEVLAR® 5 ply
- Leather thickness: min. 1 mm.



102 cm.



**STEERSOstuff®**

EN ISO 11611:2007  
CLASS 2/A1  
TÜV BP 60041277 0001  
TÜV 21173205 001



**EN ISO 11611:2007  
CLASS 2/A1**

**44-7440/7600**

**Pants with closed back**



- A-grade side split cow leather
- KEVLAR® 5 ply
- Leather thickness: min. 1 mm.

44-7440/7600M  
44-7440/7600L  
44-7440/7600XL  
44-7440/7600XXL  
44-7440/7600XXXL

110 cm.  
112 cm.  
116 cm.  
122 cm.  
128 cm.



**STEERSOstuff®**

EN ISO 11611:2007  
CLASS 2/A1  
TÜV BP 60041277 0001  
TÜV 21173205 001



**EN ISO 11611:2007  
CLASS 2/A1**

**44-7440/7648**

**Pants with breast protection and closed back, bib and brace**



- A-grade side split cow leather
- KEVLAR® 5 ply
- Leather thickness: min. 1 mm.

44-7440/7648M  
44-7440/7648L  
44-7440/7648XL  
44-7440/7648XXL  
44-7440/7648XXXL  
44-7440/7648XXXXL

136 cm.  
140 cm.  
144 cm.  
148 cm.  
152 cm.  
156 cm.



**STEERSOstuff®**

EN ISO 11611:2007  
CLASS 2/A1  
TÜV BP 60041277 0001  
TÜV 21173205 001



**EN ISO 11611:2007  
CLASS 2/A1**

## Lava Brown™ CLOTHING

### 44-71.. Apron



- A-grade side split cow leather
- KEVLAR® 5 ply
- Leather thickness: min. 1 mm.
- Self-balancing strap system

	↕	↔
44-7124	60 cm.	60 cm.
44-7136	91 cm.	60 cm.
44-7142	107 cm.	60 cm.
44-7142 W	107 cm.	80 cm.
44-7148	122 cm.	60 cm.
44-7148 W	122 cm.	80 cm.

COMFORT



44-7124  
60x60 cm.



STEERSOtuff®

EN ISO 11611:2007  
CLASS 2/A1  
TÜV BP 60041277 0001  
TÜV 21173205 001

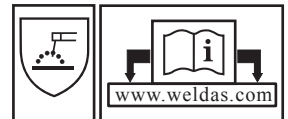

**EN ISO 11611:2007  
CLASS 2/A1**

### 44-7023 Sleeves



- A-grade side split cow leather
- KEVLAR® 5 ply
- Leather thickness: min. 1 mm.
- Balancing strap system

44-7023

↕  
58 cm.



STEERSOtuff®

EN ISO 11611:2007  
CLASS 2/A1  
TÜV BP 60041277 0001  
TÜV 21173205 001



**EN ISO 11611:2007  
CLASS 2/A1**

### 44-7028 Heavy duty arm guard (piece)



- Heavy duty
- A-grade side split cow leather
- KEVLAR® 5 ply
- Leather thickness: min. 1 mm.
- COMFOflex® lining used
- Hook and loop closure
- Inside 520 gr./m² flame retardant fabric
- See for extension 44-7114EXT (page 20)

44-7028    35 cm.    32-41 cm.    35-45 cm.



STEERSOtuff®

## Lava Brown™ CLOTHING

### 44-7106 Spats for shoe protection



- A-grade side split cow leather
- KEVLAR® 5 ply
- Leather thickness: min. 1 mm.
- With under the shoe an elastic strap to secure shoe top cover

44-7106

33-43 cm. 15 cm.



EN ISO 11611:2007  
CLASS 2/A1  
TÜV BP 60041277 0001  
TÜV 21173205 001



**EN ISO 11611:2007  
CLASS 2/A1**

### 44-7114 Spats for leg and shoe protection



- A-grade side split cow leather
- KEVLAR® 5 ply
- Leather thickness: min. 1 mm.
- With bendable insert at shin and shoe top to allow shape formation
- See for extension 44-7114EXT

44-7114

37-47 cm. 36 cm.



EN ISO 11611:2007  
CLASS 2/A1  
TÜV BP 60041277 0001  
TÜV 21173205 001



**EN ISO 11611:2007  
CLASS 2/A1**

### 44-7114EXT Diameter extension for 44-7114 and 44-7028



- A-grade side split cow leather
- KEVLAR® 5 ply
- Leather thickness: min. 1 mm.
- 15 cm. wide extension for 44-7114 and 44-7028

44-7114EXT

15 cm.



EN ISO 11611:2007  
CLASS 2/A1  
TÜV BP 60041277 0001  
TÜV 21173205 001



**EN ISO 11611:2007  
CLASS 2/A1**



## The professional's choice world wide

Weldas® on going product development and quality control supported by field testing has earned a world wide reputation for the highest quality and most innovative products.

Weldas® products are marked with appropriate EN marking standards and are manufactured in our own, by TÜV, ISO certified factory. Most of the products are also CE certified by TÜV Germany, certificates can be found on [www.weldas-ce.com](http://www.weldas-ce.com)

The pH, CHROMIUM (VI) and PCP levels of all materials in Weldas® products have been tested and meet CE health standards. Colouring is done by natural materials.

Weldas® also offers a custom designed product line for special application and marketing needs in models, packaging, barcode etc.. For more information on this contact Weldas®.

Weldas® products are warranted against manufacturing defects. Because of applications vary, it is the user's responsibility to select the right product for each application.

Weldas® is active in the following markets:

- Welding market.
- Personal protection market.
- General industrial market.

[www.weldas.com](http://www.weldas.com)



*“Global specialist  
in the protection  
of the welder”*



## Golden Brown™ CLOTHING



KEVLAR® 3 ply √



Min. 1 mm.

2 x Min. 1 mm.



1 x

**Golden Brown™ products are made of high quality side split or grain cow leather**  
*Golden Brown™ split leather products: pages 22, 23, 24, 25. Grain leather products: page 26.*

### 44-2530/P Jacket with flame retardant back



- Side split cow leather
- KEVLAR® 3 ply √
- Leather thickness: min. 1 mm.
- Back: flame retardant cotton 305 gr/m<sup>2</sup>

44-2530M/P  
 44-2530L/P  
 44-2530XL/P  
 44-2530XXL/P  
 44-2530XXXL/P

76 cm.	100 cm.
81 cm.	112 cm.
86 cm.	124 cm.
91 cm.	136 cm.
96 cm.	148 cm.



**Golden Brown™**

EN ISO 11611:2007  
 CLASS 2/A1  
 TÜV BP 60079303 0001  
 TÜV 21190228 001



**EN ISO 11611:2007  
 CLASS 2/A1**

### 44-2847 Shoulder apron



- Side split cow leather
- KEVLAR® 3 ply √
- Leather thickness: min. 1 mm.

44-2847L  
 44-2847XL

92 cm.	58 cm.
92 cm.	63 cm.



**Golden Brown™**

EN ISO 11611:2007  
 CLASS 2/A1  
 TÜV BP 60079303 0001  
 TÜV 21190228 001



**EN ISO 11611:2007  
 CLASS 2/A1**

## Golden Brown™ CLOTHING

### 44-2800 Cape sleeve



- Side split cow leather
- KEVLAR® 3 ply √
- Leather thickness: min. 1 mm.

44-2800L  
44-2800XL  
44-2800XXL



112 cm.  
124 cm.  
136 cm.



Golden Brown™

EN ISO 11611:2007  
CLASS 2/A1  
TÜV BP 60079303 0001  
TÜV 21190228 001

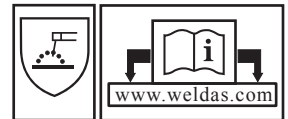

**EN ISO 11611:2007  
CLASS 2/A1**

### 44-28.. Apron for cape sleeves



- Side split cow leather
- KEVLAR® 3 ply √
- Leather thickness: min. 1 mm.

44-2828  
44-2836

↑ ↓      ↔  
71 cm.    56 cm.  
91 cm.    56 cm.



Golden Brown™

EN ISO 11611:2007  
CLASS 2/A1  
TÜV BP 60079315 0001  
TÜV 21190317 001



**EN ISO 11611:2007  
CLASS 2/A1**

### 44-21.. Apron



- Side split cow leather
- KEVLAR® 3 ply √
- Leather thickness: min. 1 mm.
- Self-balancing strap system

44-2136  
44-2142  
44-2142 W

↑ ↓      ↔  
91 cm.    60 cm.  
107 cm.   60 cm.  
107 cm.   80 cm.



Golden Brown™

EN ISO 11611:2007  
CLASS 2/A1  
TÜV BP 60079315 0001,  
TÜV BP 60079303 0001  
TÜV 21190228 001,  
TÜV 21190317 001



**EN ISO 11611:2007  
CLASS 2/A1**



## Golden Brown™ CLOTHING

### 44-2600 Pants



- Side split cow leather
- KEVLAR® 3 ply
- Leather thickness: min. 1 mm.

44-2600M	110 cm.
44-2600L	112 cm.
44-2600XL	116 cm.



Golden Brown™

EN ISO 11611:2007  
CLASS 2/A1  
TÜV BP 60079303 0001  
TÜV 21190228 001



**EN ISO 11611:2007  
CLASS 2/A1**

### 44-2648 Pants with breast protection, bib and brace



- Side split cow leather
- KEVLAR® 3 ply
- Leather thickness: min. 1 mm.

44-2648M	136 cm.
44-2648L	140 cm.
44-2648XL	144 cm.
44-2648XXL	148 cm.



Golden Brown™

EN ISO 11611:2007  
CLASS 2/A1  
TÜV BP 60079303 0001  
TÜV 21190228 001



**EN ISO 11611:2007  
CLASS 2/A1**

### 44-2321, 44-2321XL Sleeves



- Side split cow leather
- KEVLAR® 3 ply
- Leather thickness: min. 1 mm.
- Hook and loop closure at the top
- Wrist-end with elastic band included

44-2321	52 cm.	21-31 cm.	34-47 cm.
44-2321XL	52 cm.	21-31 cm.	45-60 cm.



Golden Brown™

EN ISO 11611:2007  
CLASS 2/A1  
TÜV BP 60079313 0001  
TÜV 21190282 001



**EN ISO 11611:2007  
CLASS 2/A1**

## Golden Brown™ CLOTHING

### 44-2106 Spats for leg and shoe protection



- Side split cow leather
- KEVLAR® 3 ply
- Leather thickness: min. 1 mm.
- With under the shoe an elastic strap to secure shoe top cover

44-2106

33-43 cm. 15 cm.



**Golden Brown™**

EN ISO 11611:2007  
CLASS 2/A1  
TÜV BP 60079315 0001  
TÜV 21190317 001



**EN ISO 11611:2007  
CLASS 2/A1**

### 44-2114 Spats for leg and shoe protection



- Side split cow leather
- KEVLAR® 3 ply
- Leather thickness: min. 1 mm.
- With bendable insert at shin and shoe top to allow shape formation

44-2114

37-47 cm. 36 cm.



**Golden Brown™**

EN ISO 11611:2007  
CLASS 2/A1  
TÜV BP 60079315 0001  
TÜV 21190317 001



**EN ISO 11611:2007  
CLASS 2/A1**



## Golden Brown™ CLOTHING



KEVLAR® 3 ply ∇

Min. 1 mm.

2 x Min. 1 mm.

1 x

**Golden Brown™ products are made of high quality side split or grain cow leather**  
*Golden Brown™ split leather products: pages 22, 23, 24, 25. Grain leather products: page 26.*

### 44-5530 Jacket full leather



- Grain cow leather
- KEVLAR® 3 ply ∇
- Leather thickness: min. 1 mm.

44-5530L  
 44-5530XL  
 44-5530XXL  
 44-5530XXXL

↑	81 cm.	112 cm.
	86 cm.	124 cm.
	91 cm.	136 cm.
	96 cm.	148 cm.

**Golden Brown™**

**Golden Brown™**

EN ISO 11611:2007  
 CLASS 2/A1  
 TÜV BP 60079311 0001  
 TÜV 21190268 001



  
[www.weldas.com](http://www.weldas.com)

**EN ISO 11611:2007  
 CLASS 2/A1**

### 44-5600 Pants with breast protection, bib and brace



- Grain cow leather
- KEVLAR® 3 ply ∇
- Leather thickness: min. 1 mm.

44-5600L  
 44-5600XL  
 44-5600XXL  
 44-5600XXXL

↑	140 cm.
	144 cm.
	148 cm.
	152 cm.

**Golden Brown™**

**Golden Brown™**

EN ISO 11611:2007  
 CLASS 2/A1  
 TÜV BP 60079311 0001  
 TÜV 21190268 001



  
[www.weldas.com](http://www.weldas.com)

**EN ISO 11611:2007  
 CLASS 2/A1**



## Yellowjacket® CLOTHING



KEVLAR® 3 ply ✓



Min. 1 mm.

305 gr./m<sup>2</sup>



1 x

**Yellowjacket® product is made of 305 gr./m<sup>2</sup> flame retardant cotton body and split cow leather sleeves**

### 33-3060 Jacket, flame retardant cotton with leather sleeves



- 305 gr./m<sup>2</sup> flame retardant cotton body
- split cow leather sleeves
- KEVLAR® 3 ply ✓

Yellowjacket®

EN ISO 11611:2007  
CLASS 2/A1  
TÜV BP 60079303 0001  
TÜV 21190228 001



**EN ISO 11611:2007  
CLASS 2/A1**

	↕	
33-3060S	76 cm.	108 cm.
33-3060M	76 cm.	116 cm.
33-3060L	81 cm.	127 cm.
33-3060XL	86 cm.	138 cm.
33-3060XXL	91 cm.	147 cm.
33-3060XXXL	96 cm.	158 cm.
33-3060XXXXL	96 cm.	168 cm.



## Arc Knight® CLOTHING



KEVLAR® 3 ply √



520 gr./m<sup>2</sup>



Double material



1 x

Arc Knight® 38-4350, 38-44.. and 38-4340 are made of heavy duty 520 gr./m<sup>2</sup> FR cotton with split cow leather reinforcement.

Arc Knight® 38-4330, 38-4375, 38-4328, 38-43.., 38-4360 and 38-4321XL are made of heavy duty 520 gr./m<sup>2</sup> FR cotton.

### 38-4350 Jacket with leather reinforcement



- High comfort and flexibility
- Heavy duty 520 gr./m<sup>2</sup> FR cotton with black split cow leather reinforcement
- KEVLAR® 3 ply √
- Sleeve with double closure



Arc Knight®

EN ISO 11611:2015  
CLASS 2/A1+A2  
TÜV BP 60122567 0001  
TÜV 21260757 003



EN ISO 11611:2015  
CLASS 2/A1+A2

	76 cm.	96 cm.
38-4350M	81 cm.	104 cm.
38-4350L	86 cm.	112 cm.
38-4350XL	91 cm.	120 cm.
38-4350XXL	96 cm.	128 cm.

### 38-4330 Jacket



44-7820  
44-7828  
44-7836  
44-7836XL  
(see page 17)



38-4320  
(see page 29)



44-2828  
44-2836  
(see page 23)

- High comfort and flexibility
- Heavy duty 520 gr./m<sup>2</sup> FR cotton
- KEVLAR® 3 ply √
- Possibility to add a *Lava Brown™* or *Golden Brown™* apron to this jacket



Arc Knight®

EN ISO 11611:2015  
CLASS 2/A1+A2  
TÜV BP 60122567 0001  
TÜV 21260757 003



EN ISO 11611:2015  
CLASS 2/A1+A2

	76 cm.	96 cm.
38-4330M	81 cm.	104 cm.
38-4330L	86 cm.	112 cm.
38-4330XL	91 cm.	120 cm.
38-4330XXL	96 cm.	128 cm.

## Arc Knight® CLOTHING

### 38-4375 Lab coat



- High comfort and flexibility
- Heavy duty 520 gr./m<sup>2</sup> FR cotton
- KEVLAR® 3 ply

**NEW**

38-4375M  
38-4375L  
38-4375XL  
38-4375XXL

114 cm. 96 cm.  
114 cm. 104 cm.  
114 cm. 112 cm.  
114 cm. 120 cm.



Arc Knight®

EN ISO 11611:2015  
CLASS 2/A1+A2  
TÜV BP 60122567 0001  
TÜV 21260757 003



**EN ISO 11611:2015  
CLASS 2/A1+A2**

### 38-4328 Cape sleeve



- High comfort and flexibility
- Heavy duty 520 gr./m<sup>2</sup> FR cotton
- KEVLAR® 3 ply

**NEW**

38-4328M  
38-4328L  
38-4328XL  
38-4328XXL  
38-4328XXXL



96 cm.  
104 cm.  
112 cm.  
120 cm.  
128 cm.



Arc Knight®

EN ISO 11611:2015  
CLASS 2/A1+A2  
TÜV BP 60122567 0001  
TÜV 21260757 003



**EN ISO 11611:2015  
CLASS 2/A1+A2**

### 38-4320 Apron for cape sleeve



- High comfort and flexibility
- Black split cow leather
- KEVLAR® 3 ply

**NEW**

38-4320

51 cm. 56 cm.



Arc Knight®

EN ISO 11611:2015  
CLASS 2/A1+A2  
TÜV BP 60122567 0001  
TÜV 21260757 003



**EN ISO 11611:2015  
CLASS 2/A1+A2**



## Arc Knight® CLOTHING

### 38-43.. Apron



- High comfort and flexibility
- Heavy duty 520 gr./m<sup>2</sup> FR cotton
- KEVLAR® 3 ply
- Self-balancing strap system

**NEW**

38-4336  
38-4342  
38-4342 W

91 cm. 60 cm.  
107 cm. 60 cm.  
107 cm. 80 cm.

COMFORT



Arc Knight®

EN ISO 11611:2015  
CLASS 2/A1+A2  
TÜV BP 60122567 0001  
TÜV 21260757 003



**EN ISO 11611:2015  
CLASS 2/A1+A2**

### 38-44.. Apron with leather reinforcement



- High comfort and flexibility
- Heavy duty 520 gr./m<sup>2</sup> FR cotton with black split cow leather reinforcement
- KEVLAR® 3 ply
- Self-balancing strap system

**NEW**

38-4436  
38-4442  
38-4442 W

91 cm. 60 cm.  
107 cm. 60 cm.  
107 cm. 80 cm.

COMFORT



Arc Knight®

EN ISO 11611:2015  
CLASS 2/A1+A2  
TÜV BP 60122567 0001  
TÜV 21260757 003



**EN ISO 11611:2015  
CLASS 2/A1+A2**

### 38-4360 Pants



- High comfort and flexibility
- Heavy duty 520 gr./m<sup>2</sup> FR cotton
- KEVLAR® 3 ply
- Possibility to add knee pads

**NEW**

38-4360M  
38-4360L  
38-4360XL  
38-4360XXL



79 cm.  
81 cm.  
83 cm.  
85 cm.



Arc Knight®

EN ISO 11611:2015  
CLASS 2/A1+A2  
TÜV BP 60122567 0001  
TÜV 21260757 003



**EN ISO 11611:2015  
CLASS 2/A1+A2**

## Arc Knight® CLOTHING

### 38-4340 Pants with leather reinforcement, breast protection, bib and brace



- High comfort and flexibility
- Heavy duty 520 gr./m<sup>2</sup> FR cotton with black split cow leather reinforcement
- KEVLAR® 3 ply ✓

38-4340M	136 cm.
38-4340L	140 cm.
38-4340XL	144 cm.
38-4340XXL	148 cm.
38-4340XXXL	152 cm.



**Arc Knight®**

EN ISO 11611:2015

CLASS 2/A1+A2

TÜV BP 60122567 0001

TÜV 21260757 003



**EN ISO 11611:2015  
CLASS 2/A1+A2**

### 38-4321XL Sleeves



- High comfort and flexibility
- Heavy duty 520 gr./m<sup>2</sup> FR cotton
- KEVLAR® 3 ply ✓

38-4321XL	52 cm.	21-31 cm.	45-60 cm.
-----------	--------	-----------	-----------



**Arc Knight®**

EN ISO 11611:2015

CLASS 2/A1+A2

TÜV BP 60122567 0001

TÜV 21260757 003



**EN ISO 11611:2015  
CLASS 2/A1+A2**



## Fire Fox™ CLOTHING

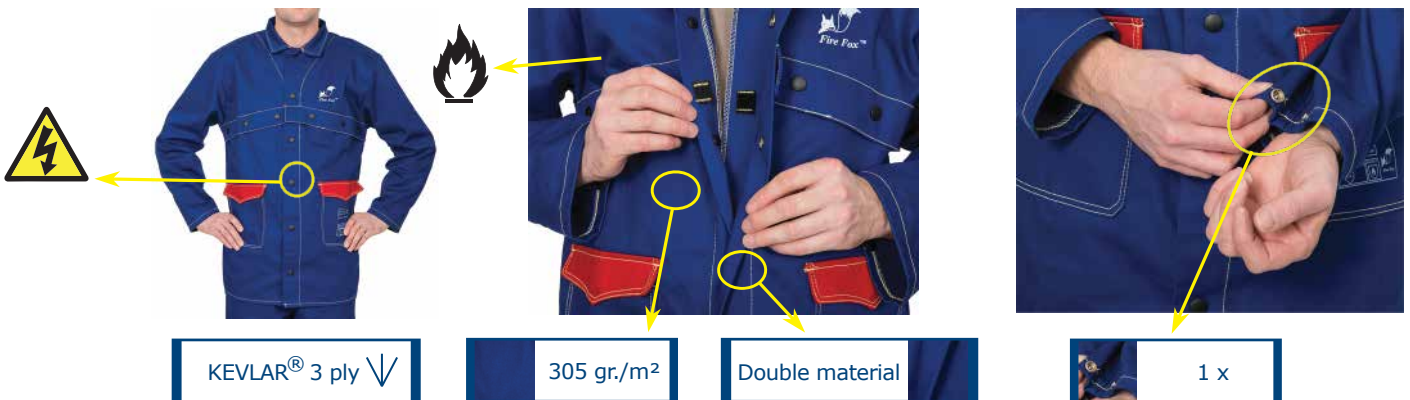

KEVLAR® 3 ply √

305 gr./m<sup>2</sup>

Double material

1 x

**Fire Fox™ clothing is made of 305 gr./m<sup>2</sup> flame retardant cotton**

### 33-2300 Jacket



44-7820  
44-7828  
44-7836  
44-7836XL  
(see page 17)

44-2828  
44-2836  
(see page 23)

- 305 gr./m<sup>2</sup> flame retardant cotton
- KEVLAR® 3 ply √
- Possibility to add a *Lava Brown™* or *Golden Brown™* apron to this jacket

33-2300M  
33-2300L  
33-2300XL  
33-2300XXL  
33-2300XXXL

76 cm. 96 cm.  
81 cm. 104 cm.  
86 cm. 112 cm.  
91 cm. 120 cm.  
96 cm. 128 cm.



**Fire Fox™**

EN ISO 11611:2007  
CLASS 1/A1+A2  
TÜV BP 60097781 0001  
TÜV 21220109 002



**EN ISO 11611:2007  
CLASS 1/A1+A2**

### 33-2600 Pants



- 305 gr./m<sup>2</sup> flame retardant cotton
- KEVLAR® 3 ply √
- Possibility to add knee pads

33-2600M  
33-2600L  
33-2600XL  
33-2600XXL  
33-2600XXXL



79 cm.  
81 cm.  
83 cm.  
85 cm.  
87 cm.



**Fire Fox™**

EN ISO 11611:2007  
CLASS 1/A1+A2  
TÜV BP 60097781 0001  
TÜV 21220109 002



**EN ISO 11611:2007  
CLASS 1/A1+A2**



## Fire Fox™ CLOTHING

### 33-2700 Pants with breast protection, bib and brace



- 305 gr./m<sup>2</sup> flame retardant cotton
- KEVLAR® 3 ply
- Possibility to add knee pads

33-2700M  
33-2700L  
33-2700XL  
33-2700XXL  
33-2700XXXL



79 cm.  
81 cm.  
83 cm.  
85 cm.  
87 cm.



**Fire Fox**™

EN ISO 11611:2007  
CLASS 1/A1+A2  
TÜV BP 60097781 0001  
TÜV 21220109 002



**EN ISO 11611:2007  
CLASS 1/A1+A2**

### 33-2800 Coverall



- 305 gr./m<sup>2</sup> flame retardant cotton
- KEVLAR® 3 ply
- Possibility to add knee pads

33-2800M  
33-2800L  
33-2800XL  
33-2800XXL  
33-2800XXXL



176 cm.  
180 cm.  
184 cm.  
188 cm.  
196 cm.



**Fire Fox**™

EN ISO 11611:2007  
CLASS 1/A1+A2  
TÜV BP 60097781 0001  
TÜV 21220109 002



**EN ISO 11611:2007  
CLASS 1/A1+A2**

### 33-2320 Sleeves

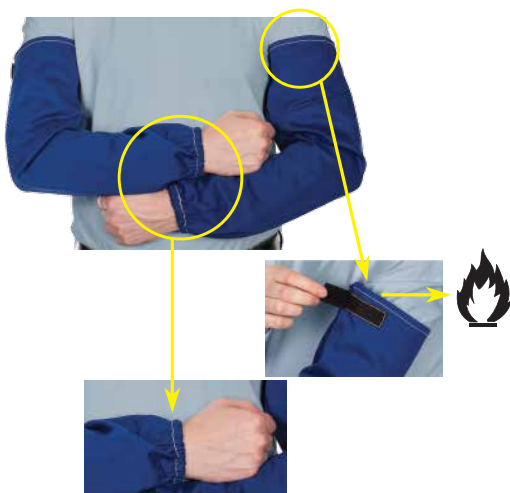

- 305 gr./m<sup>2</sup> flame retardant cotton
- KEVLAR® 3 ply

33-2320



52 cm.



19-32 cm.



36-47 cm.



**Fire Fox**™

EN ISO 11611:2007  
CLASS 1/A1+A2  
TÜV BP 60097781 0001  
TÜV 21220109 002



**EN ISO 11611:2007  
CLASS 1/A1+A2**

**Fire Fox**™

**FR COTTON CAPS**

**23-\*514 FR Cap**



**Fire Fox**™

EN ISO 11611:2007  
CLASS 1/A1+A2  
TÜV BP 60097781 0002  
TÜV 21220109 002 **CE**



**EN ISO 11611:2007  
CLASS 1/A1+A2**

**23-\*515 FR Cap**



**Choose the best size for all caps:  
\* = 1, 2, 3, 4, 5, 6, 7**

Size	Articlenumber	
7	23-1xxx	56 cm.
7 1/8	23-2xxx	57 cm.
7 1/4	23-3xxx	58 cm.
7 3/8	23-4xxx	59 cm.
7 1/2	23-5xxx	60 cm.
7 5/8	23-6xxx	61 cm.
7 3/4	23-7xxx	62 cm.

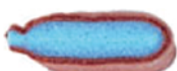

**COMFORT**



**COTTON CAPS**

**23-\*503 Camouflage**



**23-\*507 USA flag**



**23-\*524 Wild**



**Fire Fox**™

**FR BEANIE**

**23-8000 FR Beanie**



- Often used in combination with helmet
- High comfort and flexibility
- 305 gr./m<sup>2</sup> flame retardant cotton



**Fire Fox**™

EN ISO 11611:2007  
CLASS 1/A1+A2  
TÜV BP 60097781 0002  
TÜV 21220109 002 **CE**

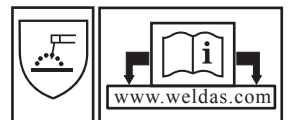

**EN ISO 11611:2007  
CLASS 1/A1+A2**

23-8000L 56-59 cm.   
23-8000XL 59-62 cm.

*Fire Fox*™

**FR COTTON DOO-RAGS**

**23-3612 FR Doo-Rag**



**23-3613 FR Doo-Rag**



*Fire Fox*™

EN ISO 11611:2007  
CLASS 1/A1+A2  
TÜV BP 60097781 0002  
TÜV 21220109 002 **CE**



**EN ISO 11611:2007  
CLASS 1/A1+A2**

**23-3611 FR Doo-Rag**



**23-3615 FR Doo-Rag**



**NEW**

- Often used in combination with helmet
- High comfort and flexibility
- Sweatband integrated in the front of the Doo-Rag
- 305 gr./m<sup>2</sup> flame retardant cotton

All Doo-Rags, one size fits all:

46-68 cm.

**COTTON DOO-RAGS**

**23-3601 Camouflage**



**23-3602 Wild**



**23-3604 USA flag**



**23-3606 Happy Hour**



**23-3607 Paradise**



**23-3609 European flag**





**Fire Fox**™

**FR HELMET HOODS**

**23-6680, 23-6680XL**

**23-6680/LV**

**23-6690**



- Connectable to helmet gear
- Hook and loop closure
- 305 gr./m<sup>2</sup> flame retardant cotton



**Fire Fox**™

EN ISO 11611:2007

CLASS 1/A1+A2

TÜV BP 60097781 0002

TÜV 21220109 002



**EN ISO 11611:2007  
CLASS 1/A1+A2**

23-6680 / 23-6680LV / 23-6690: 64 cm.  
23-6680XL: 68 cm.

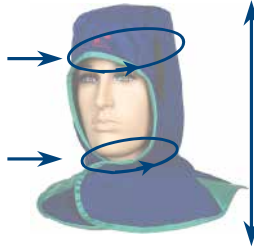

23-6680: 41 cm.  
23-6690: 41 cm.  
23-6680XL: 44 cm.  
23-6680/LV: 62 cm.

23-6680 / 23-6680LV / 23-6690: 42 - 53 cm.  
23-6680XL: 52 - 65 cm.

Multiple sizes and lengths

**TURMOflex**®

**WINTER HELMET LINERS**

**23-7701**

**23-7702**

**23-7733**



**23-7711**

**23-7766**



before washed

**SWEATSOpad®**

## HELMET COMFORTER

**“Most comfortable sweatband in the world”**

- Helmet pad and sweatband combined in one piece air cushioned **SWEATSOpad®**
- Flame retardant
- No more “helmet head”!
- No more slippage!
- No more sweat!

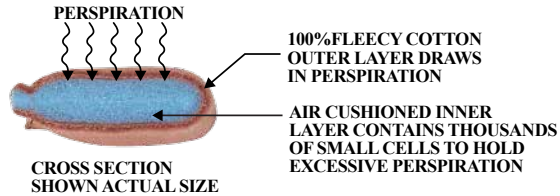

### 20-3100V, 20-3100V/17



5 x

20-3100V  
20-3100V/17

22 cm.  
17 cm.

**SWEATSOpad®**

EN ISO 11611:2003  
CLAUSE 6.6  
TÜV AK 60013119 0001  
TÜV 21120493 001



### 20-3200V



5 x

20-3200V

25 cm.

**SWEATSOpad®**

EN ISO 11611:2003  
CLAUSE 6.6  
TÜV AK 60013119 0001  
TÜV 21120493 001



### 20-3300V



5 x

20-3300V

14 cm.

**SWEATSOpad®**

EN ISO 11611:2003  
CLAUSE 6.6  
TÜV AK 60013119 0001  
TÜV 21120493 001



## LEATHER HELMET CAPS AND BIBS

44-7180



- Grain leather helmet cap
- Black grain pigskin
- Will fit over the helmet gear and can be attached with hook and loop to the top of the helmet gear.

44-7181



- Grain leather back neck protection
- Black grain pigskin
- Made to be attached with hook and loop to the cap (= art.nr. 44-7180)

- Dimensions:

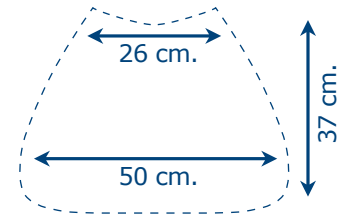

44-7182



- Grain leather front neck protection
- Black grain pigskin
- Can be attached with hook and loop to the helmet inside or outside

- Dimensions:

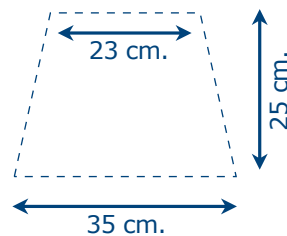

44-7184



- Split leather Front neck protection
- Black split cowhide
- Can be attached with hook and loop to the helmet inside or outside

- Dimensions:

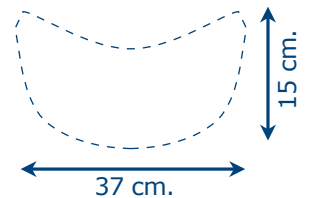

## ACCESSORIES

44-7111



- Foldable inspector mask
- Fits glass: 110 x 50 mm.
- Glass not included

KEVLAR® 3 ply √



44-7110



- Electrode bag with hanging system
- To be filled with max. 2 kg. electrodes
- Double leather construction

KEVLAR® 3 ply √

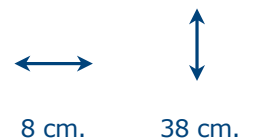



## ACCESSORIES

### 44-3006LB, 44-3006LB/PR



- High heat reflective handshield
- Split cowhide leather back with **aluminized PFR front**
- Also available in pairs (44-3006LB/PR)

EN 532  
TÜV 744-800515/25

KEVLAR® 5 ply

15 cm. 20 cm.



### 44-3008LB



- High heat reflective handshield
- Split cowhide leather back with **fiber glass front**
- Extra heat resistant

KEVLAR® 5 ply

15 cm. 20 cm.

### 44-3009BF



- High heat reflective handshield
- **Black coated fiber glass back with fiber glass front**
- Heavy duty handshield for the toughest applications

KEVLAR® 5 ply

15 cm. 20 cm.

### 10-1099



- TIG finger
- For extra protection
- For extra stability in position welding
- Silica fabric
- With hook and loop

KEVLAR® 3 ply

3,5 cm. 16 cm.

## WELDING PILLOWS



**44-7900**



- 50 x 50 x 8 cm.  
- KEVLAR® 3 ply



**44-7905**



- 39 x 33 x 3 cm.  
- KEVLAR® 3 ply

**44-7910**



- 50 x 50 x 8 cm.  
- KEVLAR® 3 ply



**44-7915**



- 39 x 33 x 3 cm.  
- KEVLAR® 3 ply

**44-7920**



- 50 x 50 x 8 cm.  
- KEVLAR® 3 ply



**44-7925**



- 39 x 33 x 3 cm.  
- KEVLAR® 3 ply

## PYTHONrap™ CABLE COVERS

### T = Tube



44-xxxxT

44-1022T	22 mm dia	1 m length lightbrown leather cable cover
44-1027T	27 mm dia	1 m length lightbrown leather cable cover

### V = Hook and loop



44-xxxxV

44-0550V	50 mm dia	5 m length lightbrown leather cable cover
44-1050V	50 mm dia	10 m length lightbrown leather cable cover
44-5030V/MTR	30 mm dia	Lightbrown leather cable cover PER METER
44-5050V/MTR	50 mm dia	Lightbrown leather cable cover PER METER

### Z = Zipper



44-xxxxZ

44-3001Z	22 mm dia	1 m length lightbrown leather cable cover
44-3010Z	22 mm dia	3 m length lightbrown leather cable cover
44-3022Z	22 mm dia	6,7 m length lightbrown leather cable cover
44-3922Z	22 mm dia	3,9 m length lightbrown leather cable cover
44-3928Z	28 mm dia	3,9 m length lightbrown leather cable cover
44-7922Z	22 mm dia	7,9 m length lightbrown leather cable cover
44-7928Z	28 mm dia	7,9 m length lightbrown leather cable cover
44-4001Z	32 mm dia	1 m length lightbrown leather cable cover
44-4525Z	37 mm dia	2,5 m length lightbrown leather cable cover
44-4535Z	37 mm dia	3,5 m length lightbrown leather cable cover



44-xxxxZ

44-3601Z	22 mm dia	1 m length black grain leather cable cover
44-3628Z	28 mm dia	1 m length black grain leather cable cover



44-xxxxZ

44-4023Z	23 mm dia	4 m length black flame retardant nylon cable cover
44-4028Z	28 mm dia	4 m length black flame retardant nylon cable cover
44-8023Z	23 mm dia	8 m length black flame retardant nylon cable cover
44-8028Z	28 mm dia	8 m length black flame retardant nylon cable cover

KEVLAR® 3 ply

Other length / diameter combinations on request



## LAVAsield® WELDING BLANKETS

50-1866

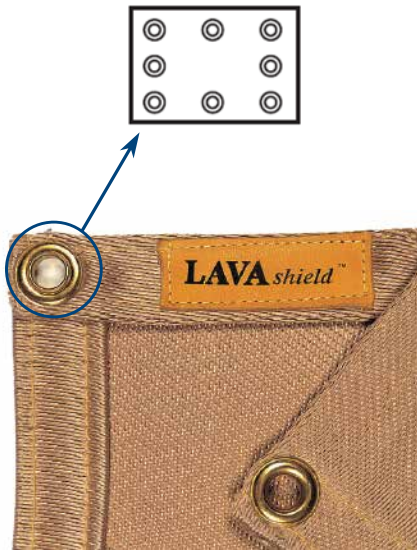

50-2368/2468



50-3068



- Silica fabric
- 174 x 174 cm.
- ± 1000°C
- ± 600 gr./m<sup>2</sup>
- KEVLAR® 3 ply ↓

- Black fiberglass
- Neoprene / neoprene coating
- 174 x 234 cm.
- ± 550°C
- ± 800 gr./m<sup>2</sup>
- KEVLAR® 3 ply ↓

- Gold fiberglass
- Acryl / neoprene coating
- 174 x 234 cm.
- ± 550°C
- ± 1000 gr./m<sup>2</sup>
- KEVLAR® 3 ply ↓

50-2472 Per meter



- Black fiberglass
- Neoprene / neoprene coating
- Not locked stitched
- Without grommets
- Width ± 183 cm.
- Total roll length ± 45 mtr.
- ± 550°C
- ± 800 gr./m<sup>2</sup>

LAVAsield®

ISO 9150:1988-12

TÜV 21278287 001

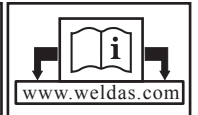

50-3072 Per meter



- Gold fiberglass
- Acryl / neoprene coating
- Not locked stitched
- Without grommets
- Width ± 183 cm.
- Total roll length ± 45 mtr.
- ± 550°C
- ± 1000 gr./m<sup>2</sup>

## LAVAshield® WELDING SCREENS

**55-6166 Orange/Red 1.74 x 1.74 mtr.**



Fits within frame 1.8 x 1.8 mtr.

- Heat sealed seams and grommets
- Nylon ties are furnished for convenience and secure fastening to the quick connection Weldas® *COMBOframe*™: 55-8668



28 pcs. plastic grommets

**LAVAshield®**

EN 1598 : 2011  
ECS: 00101-ECS-13

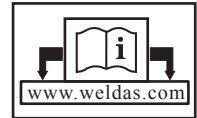

**55-6168 Orange/Red 1.74 x 2.34 mtr.**



Fits within frame 1.8 x 2.4 mtr.

- Heat sealed seams and grommets
- Nylon ties are furnished for convenience and secure fastening to the quick connection Weldas® *COMBOframe*™: 55-8668



32 pcs. plastic grommets

**LAVAshield®**

EN 1598 : 2011  
ECS: 00101-ECS-13



**55-7166 Green 1.74 x 1.74 mtr.**



Fits within frame 1.8 x 1.8 mtr.

- Heat sealed seams and grommets
- Nylon ties are furnished for convenience and secure fastening to the quick connection Weldas® *COMBOframe*™: 55-8668



28 pcs. plastic grommets

**LAVAshield®**

EN 1598 : 2011  
ECS: 00102-ECS-13



**55-7168 Green 1.74 x 2.34 mtr.**



Fits within frame 1.8 x 2.4 mtr.

- Heat sealed seams and grommets
- Nylon ties are furnished for convenience and secure fastening to the quick connection Weldas® *COMBOframe*™: 55-8668



32 pcs. plastic grommets

**LAVAshield®**

EN 1598 : 2011  
ECS: 00102-ECS-13



## COMBOframe™ MODULAR FRAME

55-8668

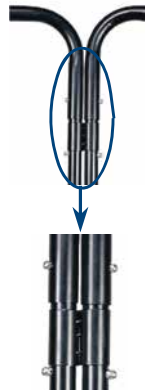
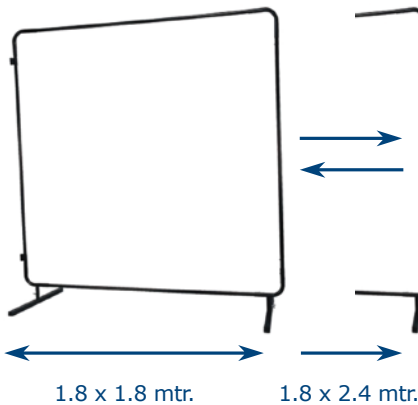

55-8668

1.8 x 1.8 mtr. / 1.8 x 2.4 mtr.

- Weldas® COMBOframe™ suitable for the welding screens: 55-6166, 55-6168, 55-7166, 55-7168
- Will be delivered as only frame (incl. swivelset), without screens

COMBOframe™



## LAVAsield® WELDING SCREENS PER METER

55-6166/MTR Orange/Red



- Heat sealed seam and grommets at one side
- Distance between grommets ± 20 cm.
- Will be delivered together with rings Ø 50 mm.
- Height ± 1.78 mtr.
- Total roll length ± 27 mtr.

LAVAsield®

EN 1598 : 2011  
ECS: 00101-ECS-13

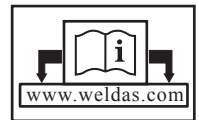

55-7166/MTR Green



- Heat sealed seam and grommets at one side
- Distance between grommets ± 20 cm.
- Will be delivered together with rings Ø 50 mm.
- Height ± 1.78 mtr.
- Total roll length ± 27 mtr.

LAVAsield®

EN 1598 : 2011  
ECS: 00102-ECS-13





LAVAsield®

## ECONO STRIP SCREENS

55-6166/Strip Orange/Red



0.68 x 1.8 mtr.

- Will be delivered together with 5 rings Ø 50 mm.



LAVAsield®

EN 1598 : 2011  
ECS: 00101-ECS-13



55-7166/Strip Green



0.68 x 1.8 mtr.

- Will be delivered together with 5 rings Ø 50 mm.



LAVAsield®

EN 1598 : 2011  
ECS: 00102-ECS-13



LAVAsield®

## CONNECTABLE WELDING SCREENS

55-6218 Orange/Red



1.37 x 1.8 mtr.

- Connectable welding screen  
- Heat sealed seams  
- Will be delivered together with 9 rings Ø 50 mm.



LAVAsield®

EN 1598 : 2011  
ECS: 00101-ECS-13

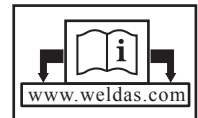

55-7218 Green



1.37 x 1.8 mtr.

- Connectable welding screen  
- Heat sealed seams  
- Will be delivered together with 9 rings Ø 50 mm.



LAVAsield®

EN 1598 : 2011  
ECS: 00102-ECS-13



## SELECTION CRITERIA

In order to make the right choice in a type and/or model of a personal protection product the user should make for himself selection criteria in order to come up with the best choice for his/her situation.

Weldas wants to help with that by giving you a number of selection criteria to start by making the right choice. Please read for that the 2 following pages carefully.

### General selection criteria for leather products such as welding gloves and welding clothing

Choosing the right product is always important to make the workplace productive but also safe.

The factors to consider include one or more of the following arguments:

- Protection arguments: resistant to heat, flame, molten splashes, UV, electricity and punctures.
- Health arguments: values of pH, Chromium, PCP or other substances that needs to be within limits.
- Durability arguments: values of abrasion resistance, tensile strength, tear resistance, heat related dimensional change resistance, reinforced seams and stress points as well as thread strength and flame resistance.
- Comfort arguments: the right sizing and fit, dexterity, fingertip sensitivity, weight, sweat vapor transmission and absorption and climate and oil resistant.

### Type of leather selection criteria for leather products such as welding gloves and welding clothing:

Type of leather	Features
Split cow leather	Heat & flame resistant, material breaths because of open structure, also low priced
Grain cow leather	Pliable and strong, water and oil resistant
Suede (reversed) pig leather	Soft and comfortable and mostly lower priced than other leathers
Grain deer leather	Fit and dexterity and, with that, very good comfort as well as water and oil resistant
Grain goat leather	Fit and dexterity, light weight and very good comfort as well as water and oil resistant
Grain bison leather	Fit and dexterity, very good comfort, high mechanical value as well as water and oil resistant

### Leather grades and terminology:

Different portions of the hide of an animal have different characteristics: the side offers the best strength and most constant quality, the shoulder offers good strength and pliability, the belly is the lowest in quality but also the most economical.

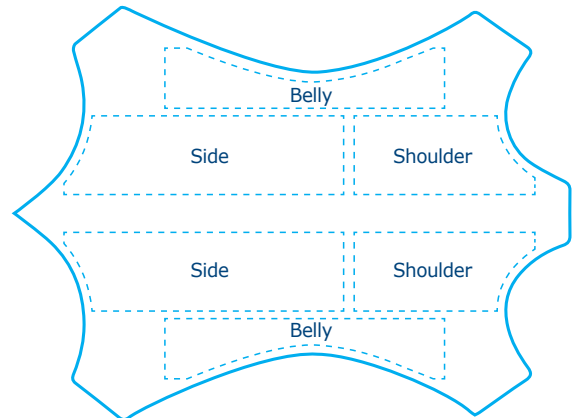
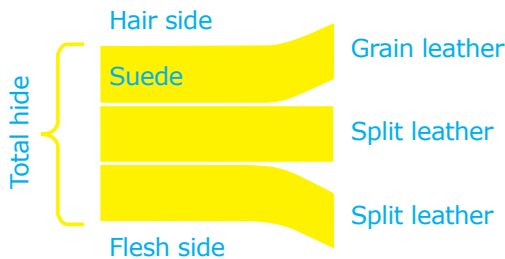

### Choice of thumb design:

Straight thumb	Wing thumb	Keystone thumb
For extra sensitivity and/or extra welding gun grip	For seamless palm durability	For comfortable fit
<i>Note on thumb/palm design: extra durability and/or cut resistance can be achieved by adding an extra reinforcement around thumb and/or on palm of the glove.</i>		

**Remark:** the choice of materials and design for welding gloves and clothing but also for other products out of the Weldas product program always depend on what the applicable European norm desires. For that reason our products are tested and certified by a, by the European Union approved, test and certification laboratory. All test reports and certificates can be found on our special CE website:

[www.weldas-ce.com](http://www.weldas-ce.com)

Weldas offers a lot of information through its catalog, website and other means of publication in order to help the user to make the right choice of product for its personal protection but it is and will always be the responsibility of the user what product he/she does choose.

## INFORMATION ON EUROPEAN NORMS

In 1989 the council of the European community agreed on the directive 89/686/EEC which requires employers to use the appropriate personal protective equipment (PPE). All products used for personal protection must be marked with the appropriate basic CE marking and extended if the applicable norm does ask for it and according to it's intended use. The directive recognizes 3 levels of protection and the products to go with these levels:

### Level 1

simple product design for minimal risk situations below 50°C. This is the only level where the manufacturer is allowed to do self-certification and where CE-minimal risk markings/imprints are allowed.

### Level 2

complex product design for industrial environments with heat, flame and/or mechanical risks. The PPE products must be tested, certified and marked to the appropriate European norms.

### Level 3

very complex product design for high risk situation like dangerous chemicals handling or very high heat. These products must be tested and certified like in level 2 but also auditing on the manufacturing quality assurance system is required.

Example of certificate:



Example of imprint of a Weldas® certified glove:

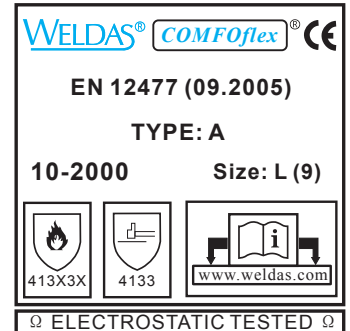

## Basic norms and pictograms on gloves used for personal protection:

EN 420 norm on sizing of gloves: see page 9 of this catalogue.

EN 388 norm on mechanical risks for gloves:

XXXX	Digit	Test Resistance	Level 1	Level 2	Level 3	Level 4	Level 5
	1st	Abrasion (# cycles)	100	500	2000	8000	-
2nd	Blade Cut (index)	1,2	2,5	5,0	10,0	20,0	
3rd	Tear (Newton)	10	25	50	75	-	
4th	Puncture (Newton)	20	60	100	150	-	

EN 12477 norm on welding gloves and allied processes:

Minimum requirements	according to EN...	Type A		Type B	
		Minimum Rating	Minimum Rating	Minimum Rating	Minimum Rating
Electrical Insulation	pr1149-2	R≥10 <sup>6</sup> Ω		R≥10 <sup>5</sup> Ω	
Abrasion Resistance	EN 388	2	500 cycles	1	100 cycles
Blade Cut Resistance	EN 388	1	Index 1,2	1	Index 1,2
Tear Resistance	EN 388	2	25 N	1	10 N
Puncture Resistance	EN 388	2	60 N	1	20 N
Burning Behaviour	EN 407	3		2	
Contact Heat Resistance	EN 407	1	100° C	1	100° C
Convective Heat Resistance	EN 407	2	HTI≥7	0	
Small Molten Splash Resistance	EN 407	3	25 Droplets	2	15 Droplets
Dexterity (pick up of rod dia.)	EN 420	1	≤11mm	4	≤6,5mm

EN 407 norm thermal risks for gloves:

XXXXXX	Digit	Test Resistance	Digit	Test Resistance
	1st	Burning behaviour	5th	Small splashes of molten metal
2nd	Contact heat	6th	Large quantities of molten metal	
3rd	Convective heat			
4th	Radiant heat			

EN 11611 norm on welding clothing and allied processes:

XXXXXX	Requirement(s)	Class 1	Class 2
	Tensile strength — woven outer textile material — leather		
Tear strength			20 N
Dimensional change of woven textile materials Dimensional change of knitted textile materials			≤ ± 3 % ≤ ± 5 %
Flame spread <sup>a</sup> : For ISO 15025:2000, Procedure B, this requirement is not applicable.		ISO 15025:2000, Procedure A, (surface ignition) ; ISO 15025:2000, Procedure B, (edge ignition) No flaming to the top or either side edge; No hole formation a; No flaming or molten debris Mean afterflame ≤ 2 s; Mean afterglow ≤ 2 s	
Impact of spatter		15 drops	25 drops
Heat transfer (radiation)		RHTI 24 W 7	RHTI 24 W 16
Burst strength		200kPa	
Seam strength — textile material — leather		225 N 110 N	
Electrical resistance		>10 <sup>5</sup> Ω	
Innocuousness		See 6.11	
Leather		Fat content: ≤ 15 %	



## MANUFACTURER:



## TESTING AND CERTIFICATION PARTNERS



[WWW.WELDAS-CE.COM](http://WWW.WELDAS-CE.COM)

**Weldas® Europe B.V.**  
**Blankenweg 18**  
**NL-4612 RC Bergen op Zoom**  
**Holland**

**Tel.: +31 164 27 46 50**  
**Fax: +31 164 27 46 55**  
**europa@weldas.eu**  
**[www.weldas.com](http://www.weldas.com)**

KEVLAR® is a registered trademark of E.I. DuPont Co.  
Weldas® is a registered trademark of Weldas® Company.  
Arc Knight® is a registered trademark of Weldas® Co.  
COMFOflex® is a registered trademark of Weldas® Co.  
DEERSOsoft® is a registered trademark of Weldas® Co.  
LAVAshield® is a registered trademark of Weldas® Co.  
STEERSOuff® is a registered trademark of Weldas® Co.  
SWEATSOpad® is a registered trademark of Weldas® Co.  
TURMOflex® is a registered trademark of Weldas® Co.  
Yellowjacket® is a registered trademark of Weldas® Co.  
Arc Queen™ is a trademark of Weldas® Co.  
COMBOframe™ is a trademark of Weldas® Co.  
Fire Fox™ is a trademark of Weldas® Co.  
Golden Brown™ is a trademark of Weldas® Co.  
Lava Brown™ is a trademark of Weldas® Co.  
PYTHONrap™ is a trademark of Weldas® Co.  
SOFTouch™ is a trademark of Weldas® Co.  
ThunderingBison™ is a trademark of Weldas® Co.

©0118/1 Weldas® Europe B.V.  
Printing and typesetting errors reserved.

## YOUR DISTRIBUTOR:

